



13-Year Specialized In Hydroponics Manufacturing



CONTACT US:

Website: www.orientrise.com <http://growstar.en.alibaba.com>
 Mobile/What'Sapp/Wechat: +86-18650350075
 Email: mark@orientrise.com
 Skype: a233614 marktu6
 Tel: +86-595-22875850

Inline Duct Fan

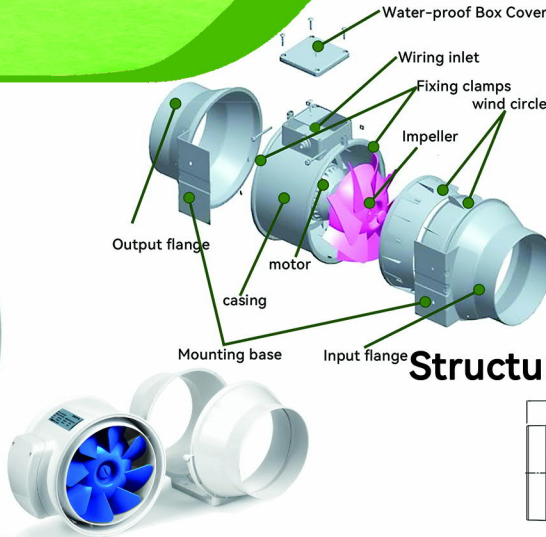

Performance Curve

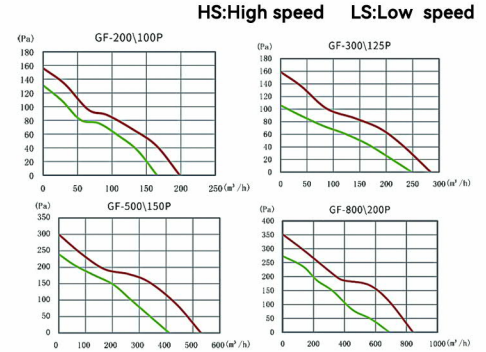

Structure And Dimensions Drawing

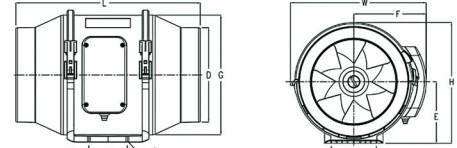

Performance Parameters

Model	Speed	Voltage /Frequency	Current (Amps)	Power (W)	Speed (RPM)	Airflow (m³/h)	Air Pressure (Pa)	Noise (dB)	Net Weight (kgs)
GF-200\100P	H	220-240V/50Hz	0.12	26	2200	198	156	31	1.4
	L		0.11	23	1850	165	131	26	
	H	100-120V/60Hz	0.24	30	2200	198	156	31	
	L		0.22	28	1850	165	131	26	
GF-300\125P	H	220-240V/50Hz	0.14	33	2200	284	159	32	1.4
	L		0.13	28	1850	248	106	26	
	H	100-120V/60Hz	0.30	32	2200	284	159	32	
	L		0.26	27	1850	248	106	26	
GF-500\150P	H	220-240V/50Hz	0.22	54	2550	530	300	33	1.9
	L		0.19	44	1850	410	240	29	
	H	100-120V/60Hz	0.58	65	2550	530	300	33	
	L		0.49	53	1850	410	240	29	
GF-800\200P	H	220-240V/50Hz	0.53	128	2450	840	352	63	2.7
	L		0.52	123	1950	690	274	55	
	H	100-120V/60Hz	1.47	162	2450	840	352	63	
	L		1.27	146	1950	690	274	55	

Model	A(mm)	B(mm)	C(mm)	ΦD(mm)	E(mm)	F(mm)	G(mm)	L(mm)	W(mm)	H(mm)
GF-200\100P	60	59	4-Φ4.5	97	99	112	162	302	208	188
GF-300\125P	60	59	4-Φ4.5	123	99	112	162	256	208	188
GF-500\150P	60	77	4-Φ4.5	147	105	123	186	288	232	206
GF-800\200P	60	110	4-Φ4.5	198	115	133	207	302	252	226

Performance Curve

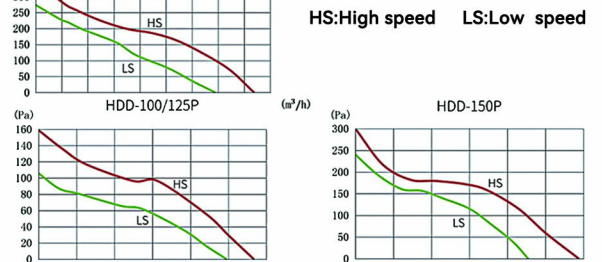

Structure And Dimensions Drawing

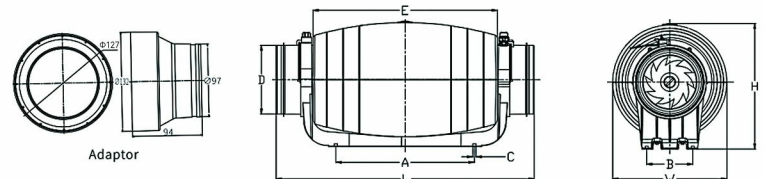

Super Silent Inline Fan



Performance Parameters

Model	Speed	Voltage /Frequency	Current (Amps)	Power	Speed (RPM)	Airflow (m³/h)	Air Pressure (Pa)	Noise (dB)	Net Weight (kgs)
HDD-100/125P	H	220-240V/50Hz	0.14	33	2250	284	159	25	2.8
	L		0.13	28	1850	248	106	22	
HDD-150P	H	220-240V/50Hz	0.25	50	2550	530	300	31	4.0
	L		0.20	43	1850	410	240	26	
HDD-200P	H	220-240V/50Hz	0.57	128	2450	840	352	35	5.9
	L		0.52	123	1950	690	274	29	

Model	A (mm)	B(mm)	C(mm)	ΦD(mm)	E(mm)	L(mm)	W(mm)	H(mm)
HDD-100/125P	248	82	4-Φ5.5	97/123	330	580/462	205	225
HDD-150P	251	95	4-Φ5.3	149/158	352	488	221	244
HDD-200P	339	128	4-Φ5.6	198	436	567	262	301

Energy-Saving Inline Fan



Structure And Dimensions Drawing

Model No.	Voltage (V)	Current (Amps)	Power (W)	Speed (RPM)	Airflow (m³/h)	Air Pressure (Pa)	Net Weight (kgs)
HI-160EC	100~240	0.7 MAX.1.40	77	4300	798	542	2.0
HI-200EC	100~120	0.1 MAX.1.40	110	3500	1292	485	2.7

HS:High speed LS:Low speed

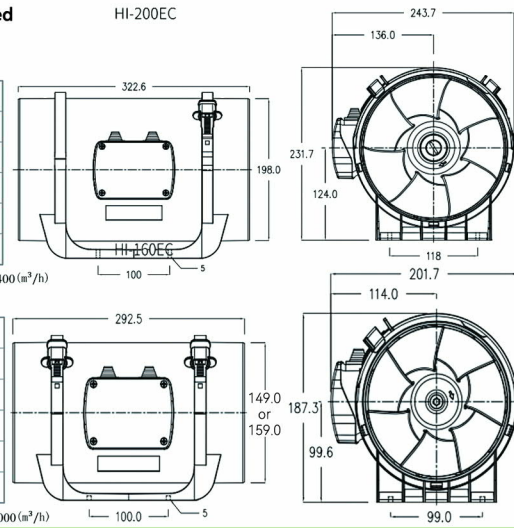
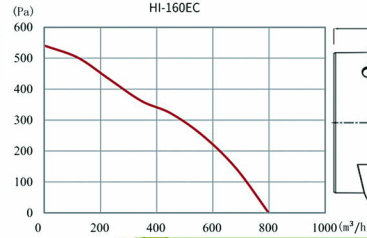
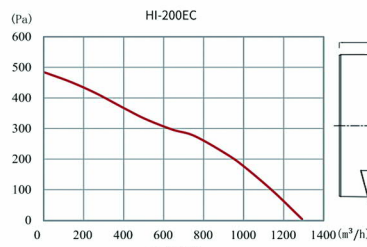

Performance Curve

HS:High speed LS:Low speed

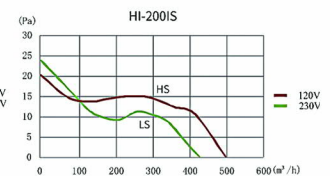
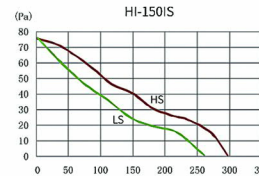

Booster Fan



Performance Parameters

Model NO.	Voltage/Frequency (V/Hz)	Current (Amps)	Power (W)	Speed (RPM)	Airflow (m³/h)	Air Pressure (Pa)	Noico INOIsE (dB)	Net Weight (kgs)
HI-100IS	220~240/50	0.11	15	2600	43	36	35	0.8
	100~120/60	0.15	15	3200	56	48	38	
HI-150IS	220~240/50	0.32	34	2450	258	75	41	1.2
	100~120/60	0.68	37	2800	295	75	45	
HI-200IS	220~240/50	0.31	40	2350	501	20	50	1.4
	100~120/60	0.80	46	2350	431	24	50	

Structure And Dimensions Drawing

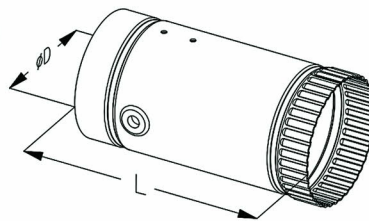

MODEL	D(mm)	L(mm)
HI-100IS	100	185
HI-150IS	150	185
HI-200IS	200	185

Silent Centrifugal Fan



Performance Parameters

Model	A(mm)	B(mm)	ΦC(mm)	ΦD(mm)	E(mm)	F(mm)	ΦG(mm)	L(mm)	W(mm)	H(mm)
HEE-100I	36	166	5	97	163.5	136.5	244	285	208	258
HEE-125I	36	166	5	123	163.5	136.5	244	285	198	258
HEE-150I	40	250	5	147	208.5	181.5	333	375	264	348
HEE-160I	40	250	5	157	208.5	181.5	333	375	258	348
HEE-200I	40	250	5	197	208.5	181.5	333	375	242	348
HEE-250I	40	250	5	247	208.5	181.5	333	375	217	348
HEE-315I	50	270	5	313	243	215	403	444	253	416

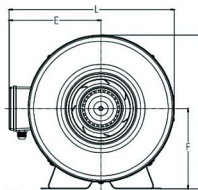
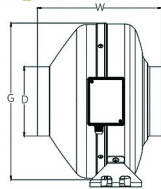

Performance Curve

HS:High speed LS:Low speed

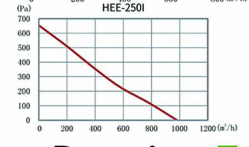
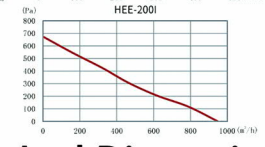
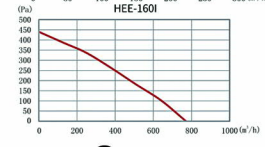
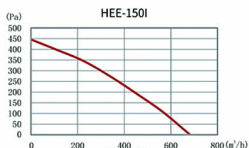
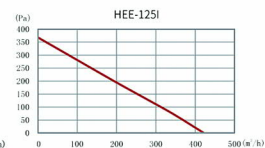

Structure And Dimensions Drawing

Model No.	Voltage (V)	Frequency (Hz)	Power (W)	Current (Amps)	Speed (RPM)	Airflow (m³/h)	Air Pressure (Pa)	Noise (dB)	Net Weight (kgs)
HEE-100I	220~240	50	51	0.24	2700	262	300	44	3.1
	100~120	60	75	0.60	2700	262	339	44	3.1
HEE-125I	220~240	50	73	0.35	2560	420	368	45	3.2
	100~120	60	94	0.85	2600	426	390	45	3.2
HEE-150I	220~240	50	110	0.58	2450	680	446	47	4.3
	100~120	60	140	1.30	2550	707	483	47	4.3
HEE-160I	220~240	50	110	0.58	2450	770	440	48	4.4
	100~120	60	140	1.30	2550	801	476	46	4.4
HEE-200I	220~240	50	175	0.75	2420	945	674	59	5.2
	100~120	60	180	1.60	2420	945	700	59	5.2
HEE-250I	220~240	50	175	0.80	2420	979	654	59	5.1
	100~120	60	180	1.60	2420	979	677	59	5.1
HEE-315I	220~240	50	225	1.28	2520	1660	738	65	6.6
	100~120	60	335	2.80	2800	1840	900	65	6.6

Contact Us:

Website: www.orientrise.com

<http://growstar.en.alibaba.com>

Skype: a233614 & marktu6

Email: mark@orientrise.com

Tel: +86-595-22875850

Mobile/What'sapp/Wechat: +86-18650350075

